

Desde 1986
aluminorte
alumínio e acessórios

Soluções para
alumínio desde
1986

GRADIL
SPARTA®

Sistema
Aluminorte
Cátalogo completo

VERSÃO IX – JUNHO 2026

GRADIL SPARTA

5 OPÇÕES DE
CORRIMÃO

+

3 OPÇÕES DE
GUARDA CORPO



SISTEMA TESTADO E
APROVADO PELO
ITEC – NBR 14.718

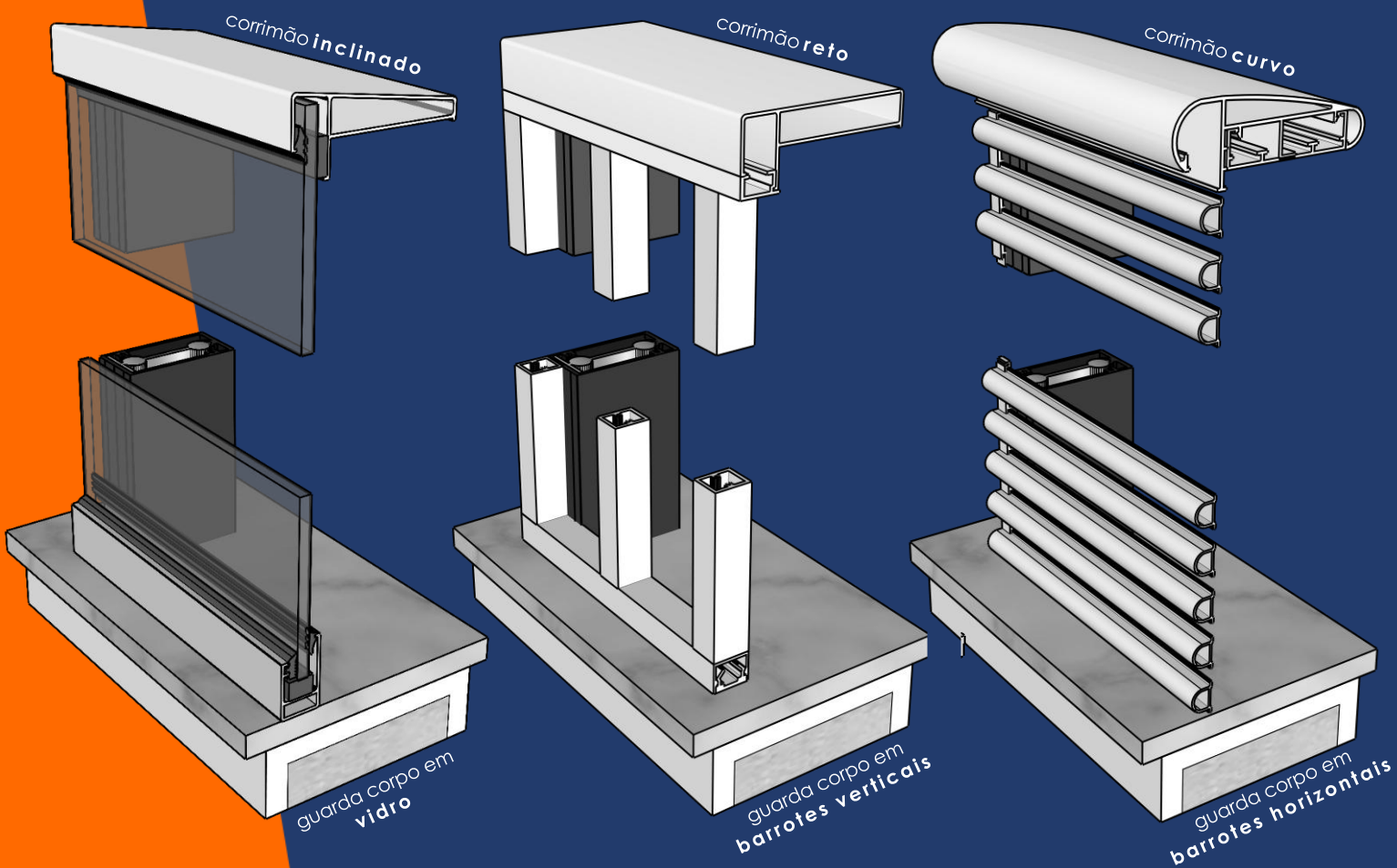

aluminorte Desde 1986
alumínio e acessórios

ÍNDICE DE PERFIS ————— **01**

PERFIS ————— **02**

PROJETOS ORIENTATIVOS ——— **10**

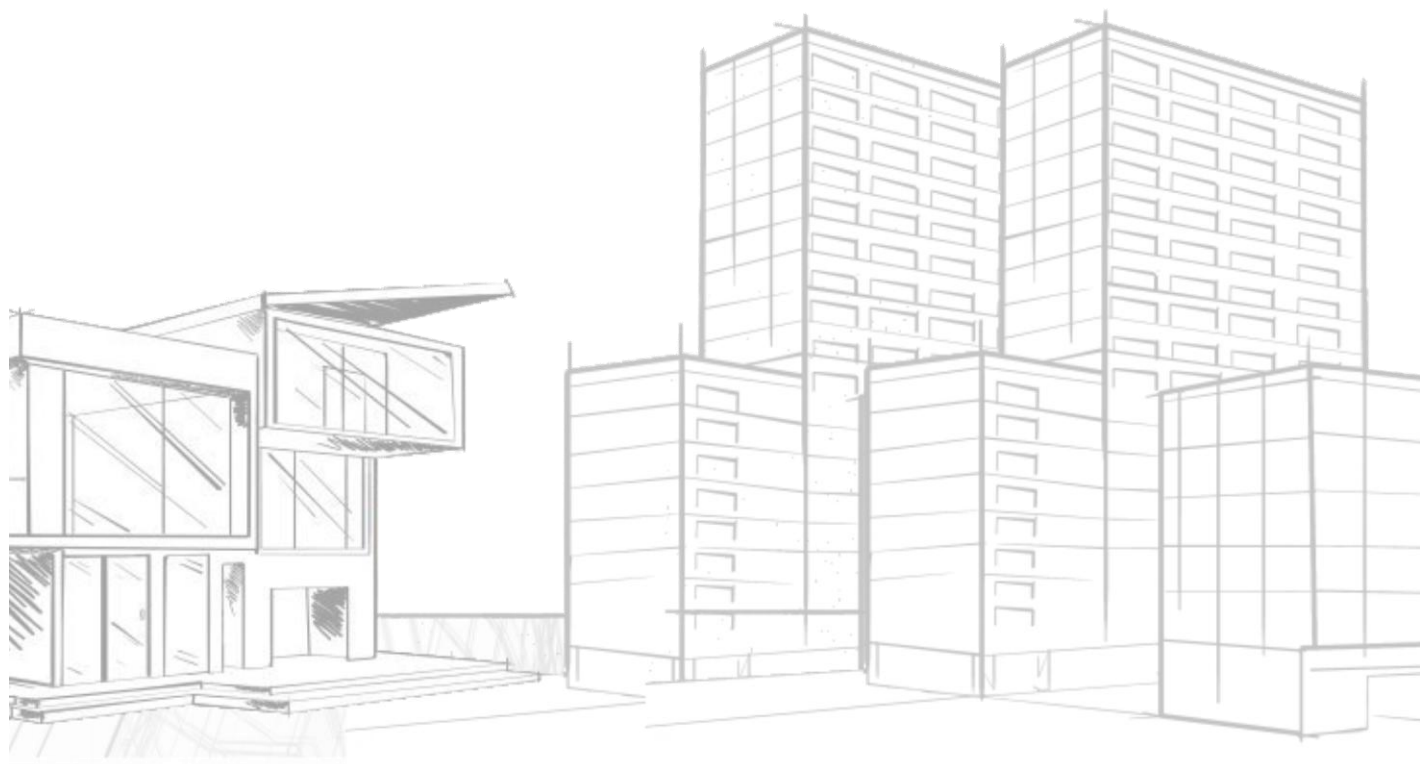

	CÓDIGO	DESCRIÇÃO	PESO	PÁG	
	CG171	Suporte Vidro	0,371 Kg/m	7	
	GR001	Barrote	0,179 Kg/m	11	
	GR002	Suporte Vidro	0,572 Kg/m	7	
	GR006	Guia do Barrote	0,733 Kg/m	11	
	GR017	Coluna do Gradil	1,415 Kg/m	5	
	GR018	Luva Corrimão	0,389 Kg/m	8	
	GR019	Corrimão Curvo	1,669 Kg/m	3	
	GR020	Suporte do Corrimão	0,591 Kg/m	3	
	GR022	Pontaletes	1,445 Kg/m	7	
	GR031	Corrimão Inclinado	1,065 Kg/m	2	
	GR032	Suporte do Gradil	0,609 Kg/m	5	
	GR033	Coluna de Canto do Gradil	1,653 Kg/m	6	
	GR034	Corrimão Reto	1,031 Kg/m	2	
	GR035	Suporte do Barrote	0,253 Kg/m	9	
	GR036	Tampa Click	0,238 Kg/m	8	
	GR037	Contratampa Click	0,272 Kg/m	8	
	GR038	Barrote	0,556 Kg/m	9	
	CG022	Barrote	0,252 Kg/m	10	
	CG021	Barrote	0,329 Kg/m	10	
	SU094	Barrote	0,371 Kg/m	10	
	GR039	Suporte Superior Barrote	0,253 Kg/m	9	
	GR040	Coluna Slim	1,074 Kg/m	5	
	GR041	Corrimão abaulado	1,129 kg/m	4	
	TR-135	Corimão redondo	1,271 kg/m	4	

GR - 031

Corrimão Inclinado
1,065 Kg/m

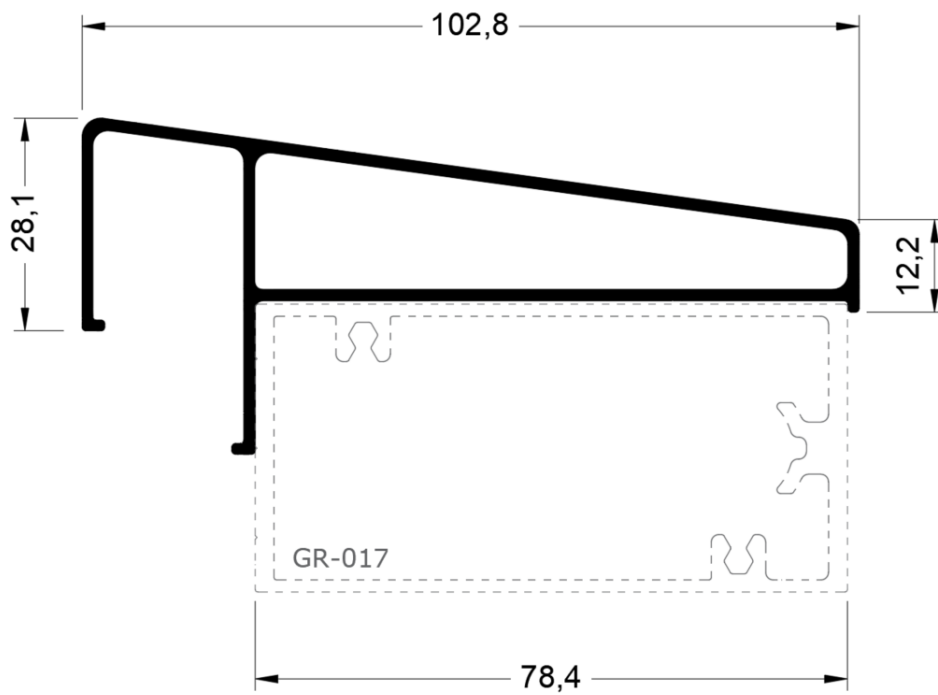

GR - 034

Corrimão Reto
1,031 Kg/m

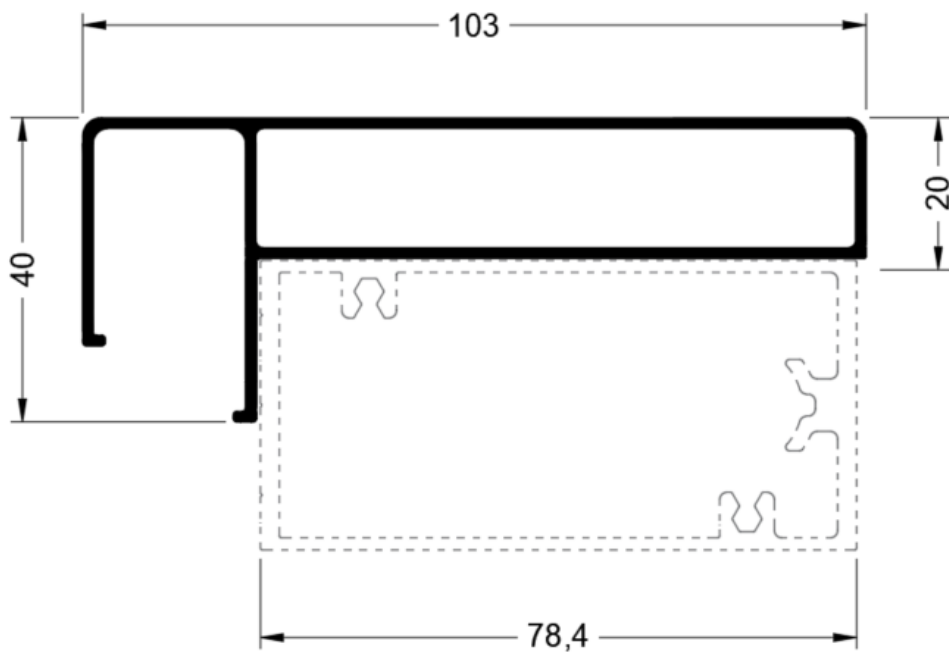

GR - 019

Capa do Corrimão
1,669 Kg/m

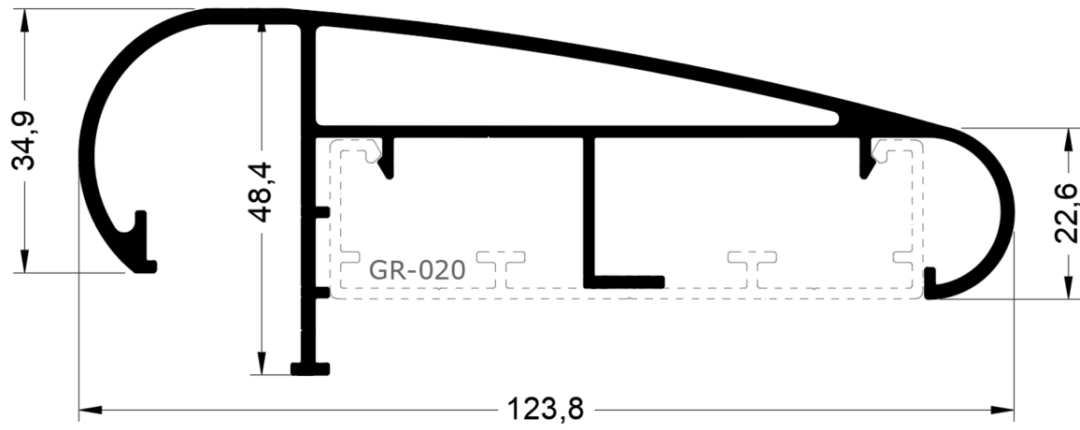

GR - 020

Suporte da Capa
0,591 Kg/m

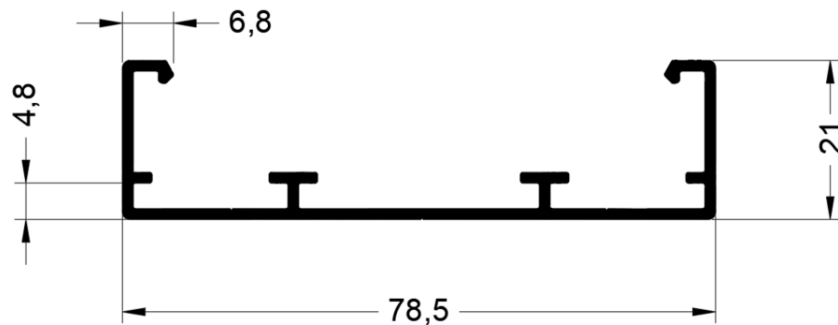

GR - 041

Corrimão abaulado
1,129 Kg/m

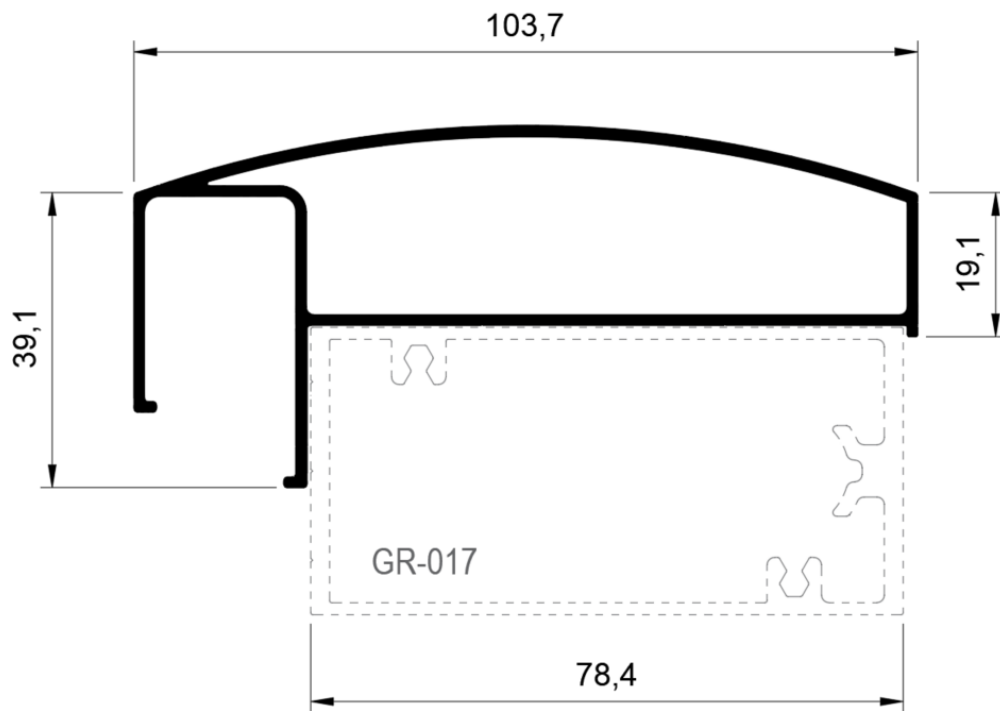
**TR-135**

Corrimão redondo
1,271 Kg/m

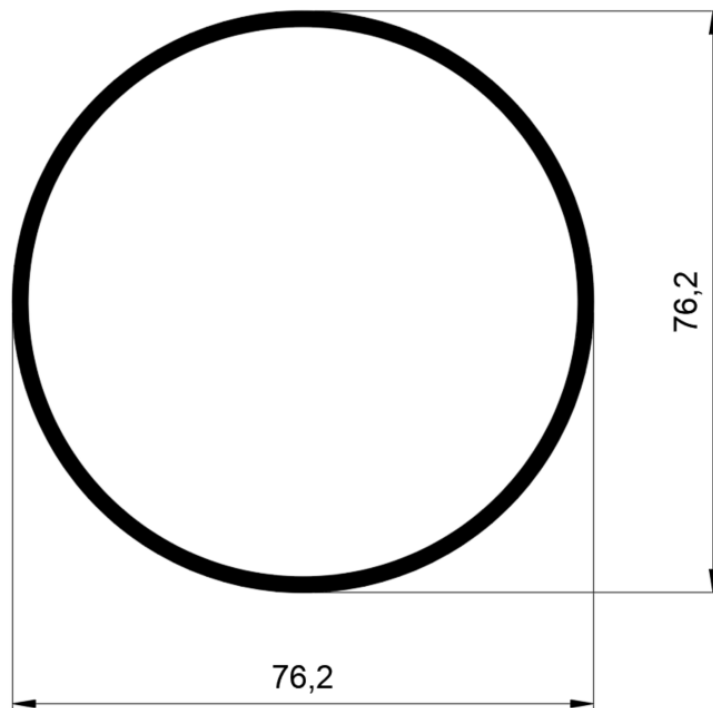

GR - 032

Suporte do Gradil
0,609 Kg/m

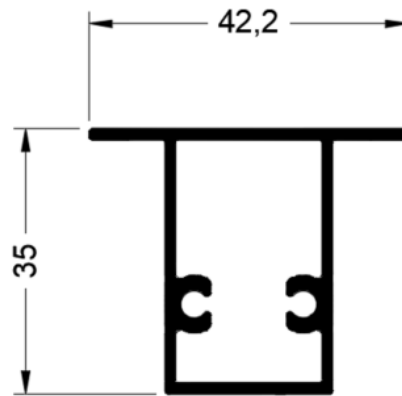
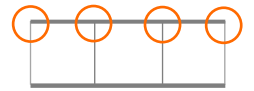

GR - 017

Coluna do Gradil
1,415 Kg/m

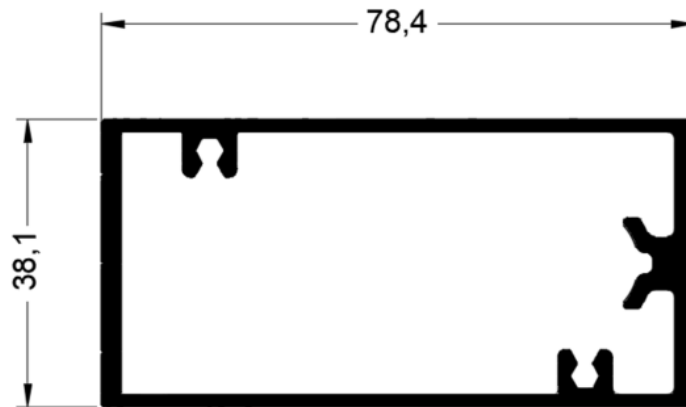
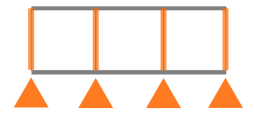

GR - 040

Coluna Slim
1,074 Kg/m

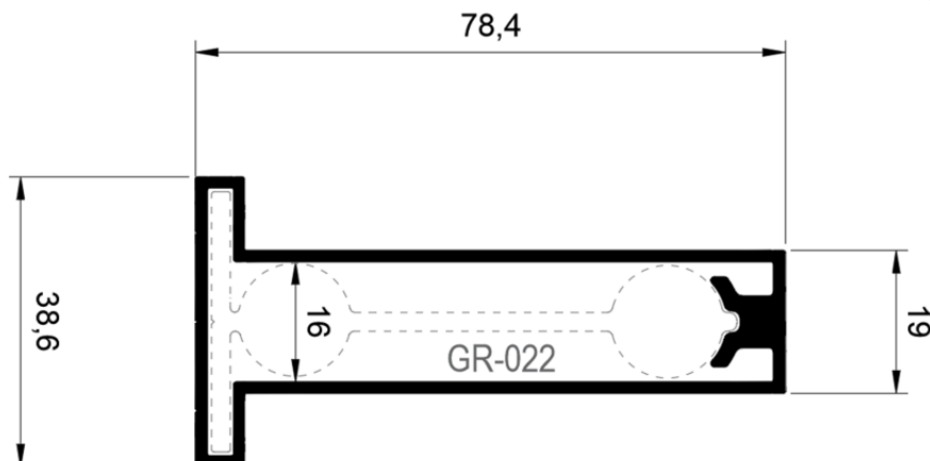
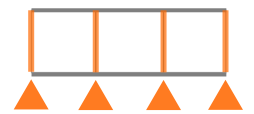

GR - 033

Coluna de Canto do Gradil
1,653 Kg/m

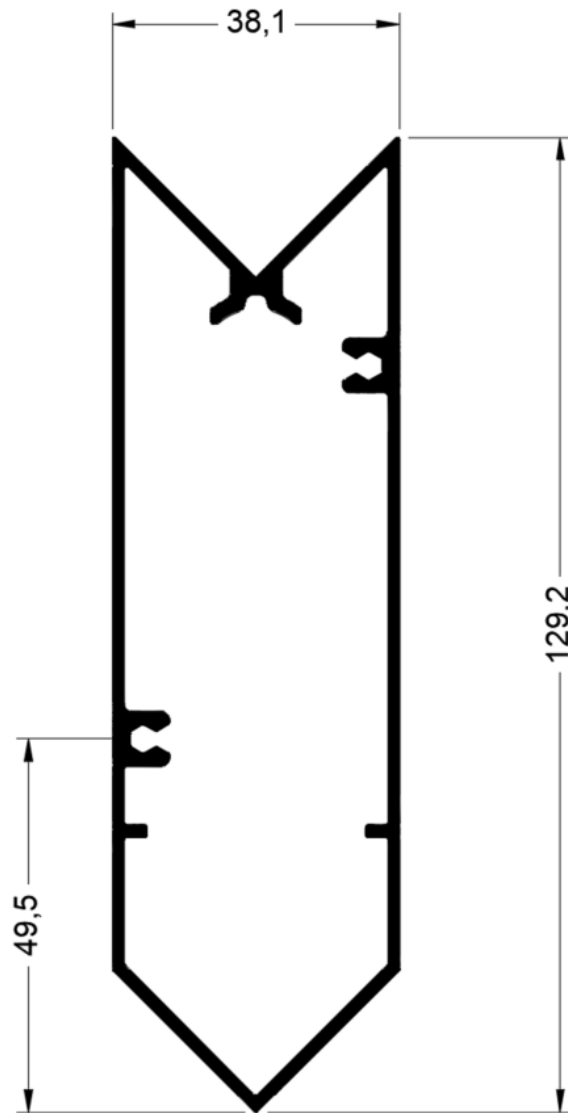
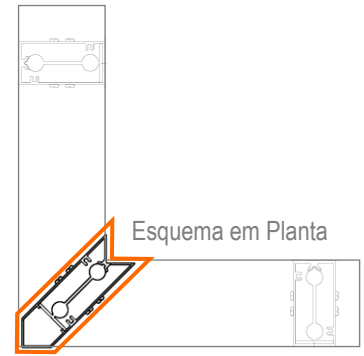

GR - 022

Pontalete
1,445 Kg/m

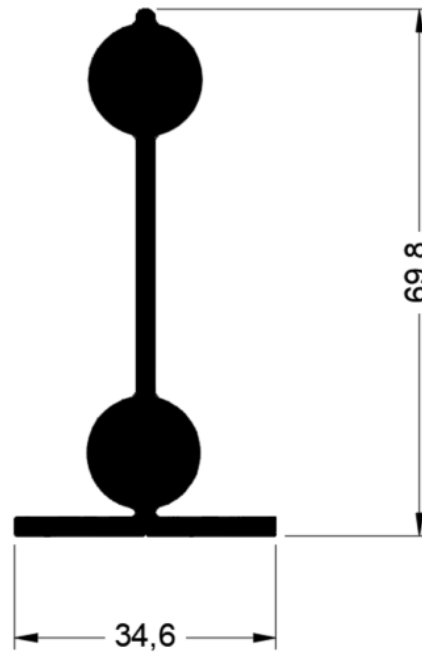
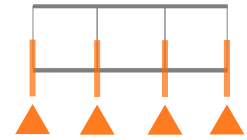

GR - 002

Suporte Vidro
0,572 Kg/m

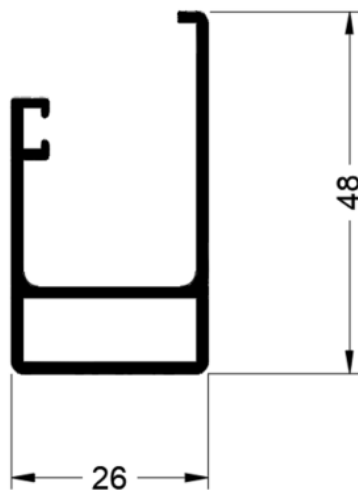

CG - 171

Suporte Vidro
0,371 Kg/m

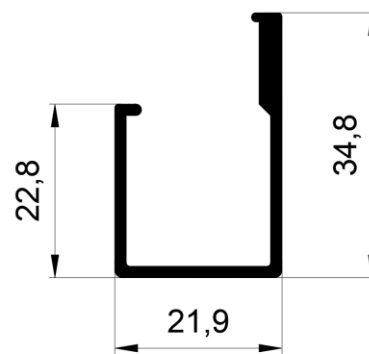

GR - 037

Contratampa Click
0,272 Kg/m

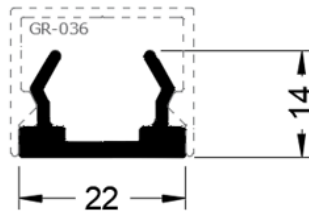
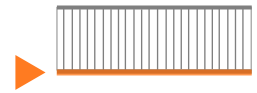

GR - 036

Tampa Click
0,238 Kg/m

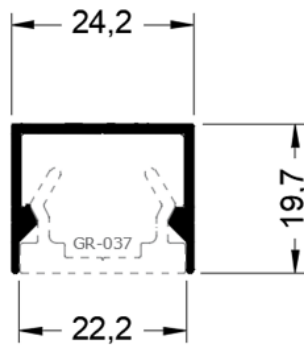
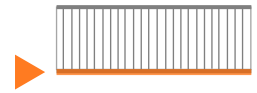

GR - 018

Luva do Corrimão
0,389 Kg/m

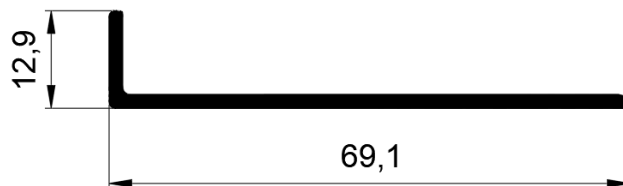
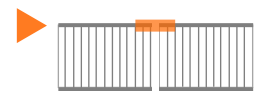

GR - 039

Suporte do Barrote
0,253 Kg/m

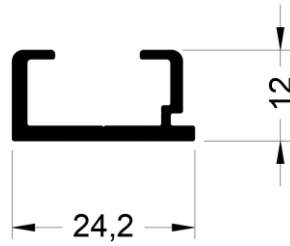
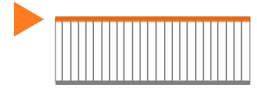
**GR - 035**

Suporte do Barrote Inferior
0,250 Kg/m

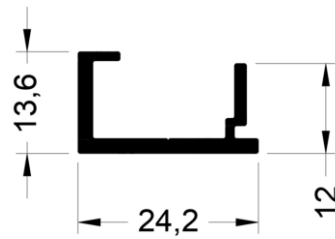
**GR - 038**

Barrote
0,556 Kg/m

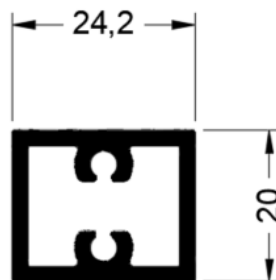

CG - 022 (D-070)

Barrote
0,252 Kg/m

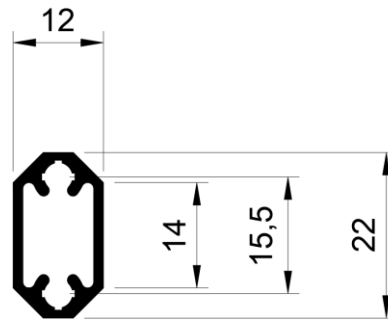

CG - 021 (D-082)

Barrote
0,329 Kg/m

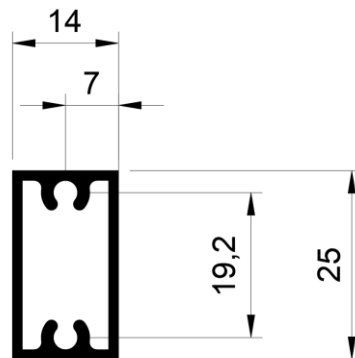

SU - 094

Barrote
0,371 Kg/m

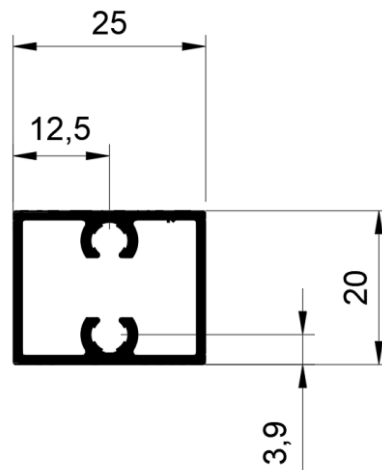

GR - 001

Barrote
0,179 Kg/m

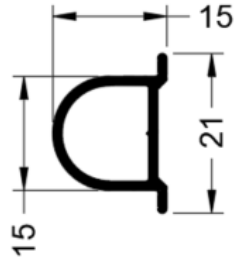

GR - 006

Guia do Barrote
0,733 Kg/m

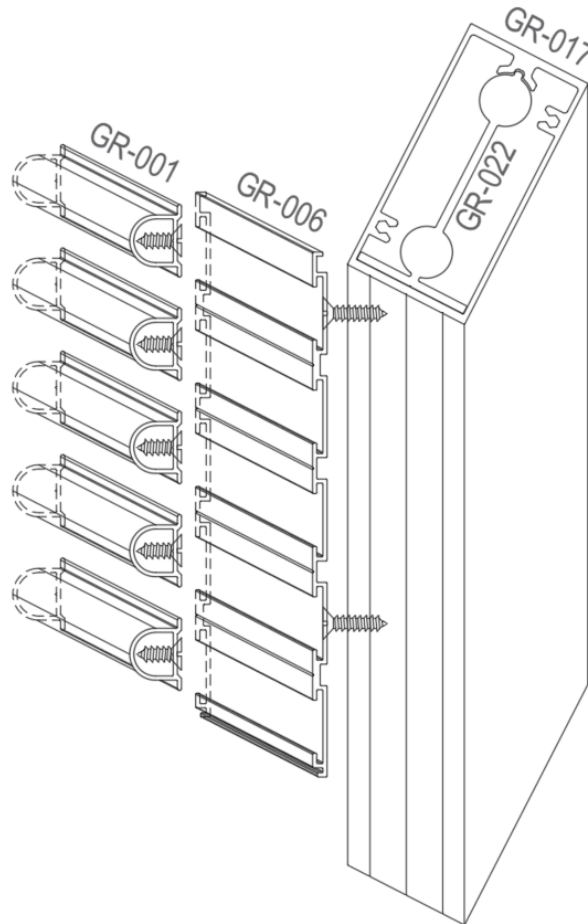
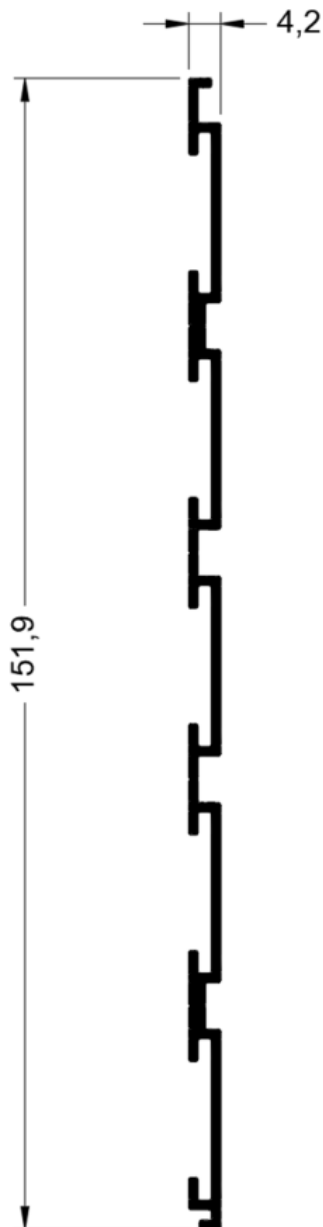
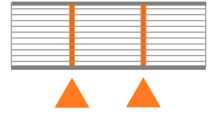

Esquema de montagem em 3D - fora de escala
(detalhes na pág. 15)

Guarda Corpo com Corrimão Inclinado e Vidro com Coluna de Canto

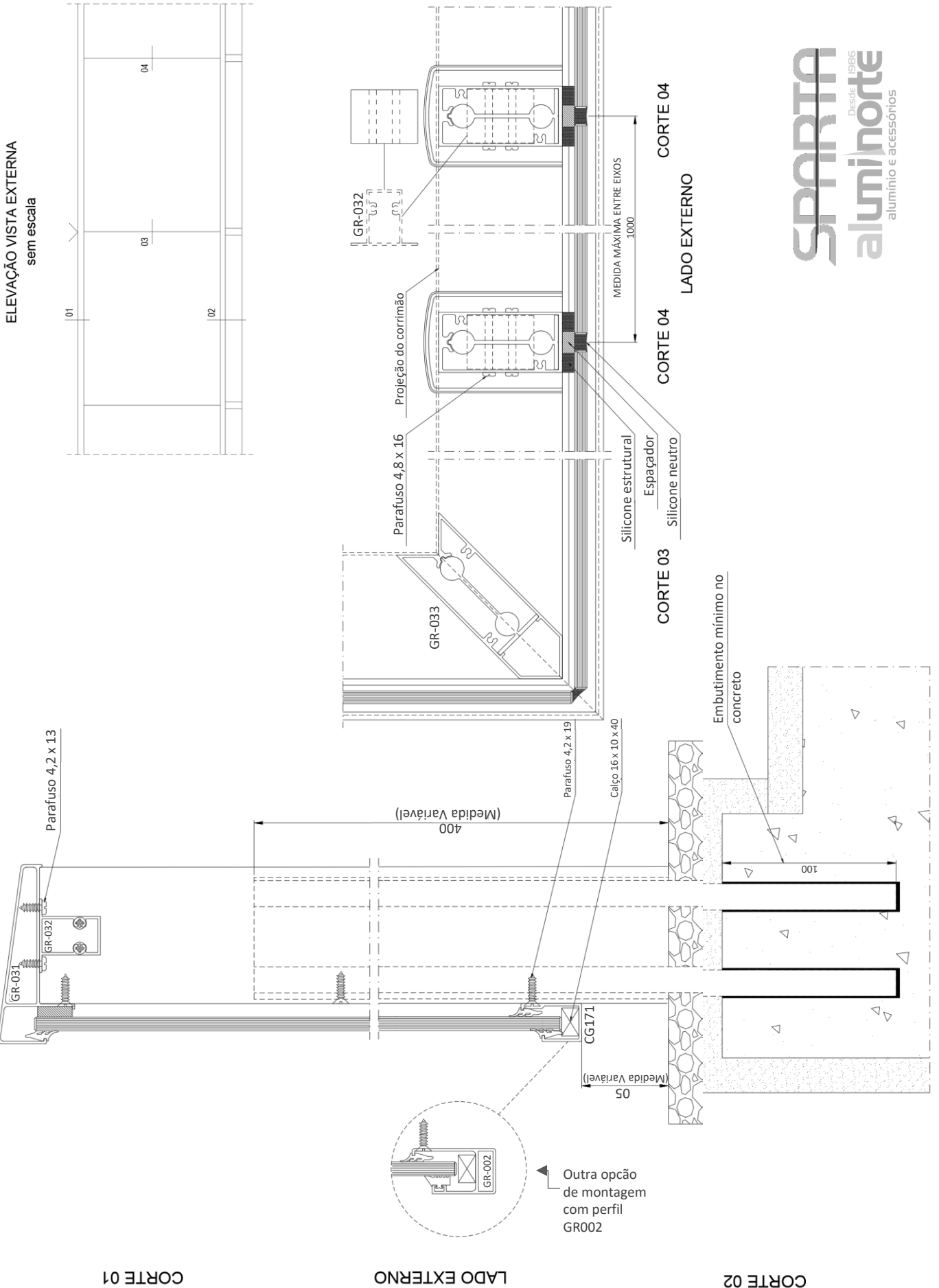

SPARTA
Desde 1986
aluminonorte
alumínio e acessórios

Guarda Corpo com Corrimão Reto e Vidro com Coluna de Canto

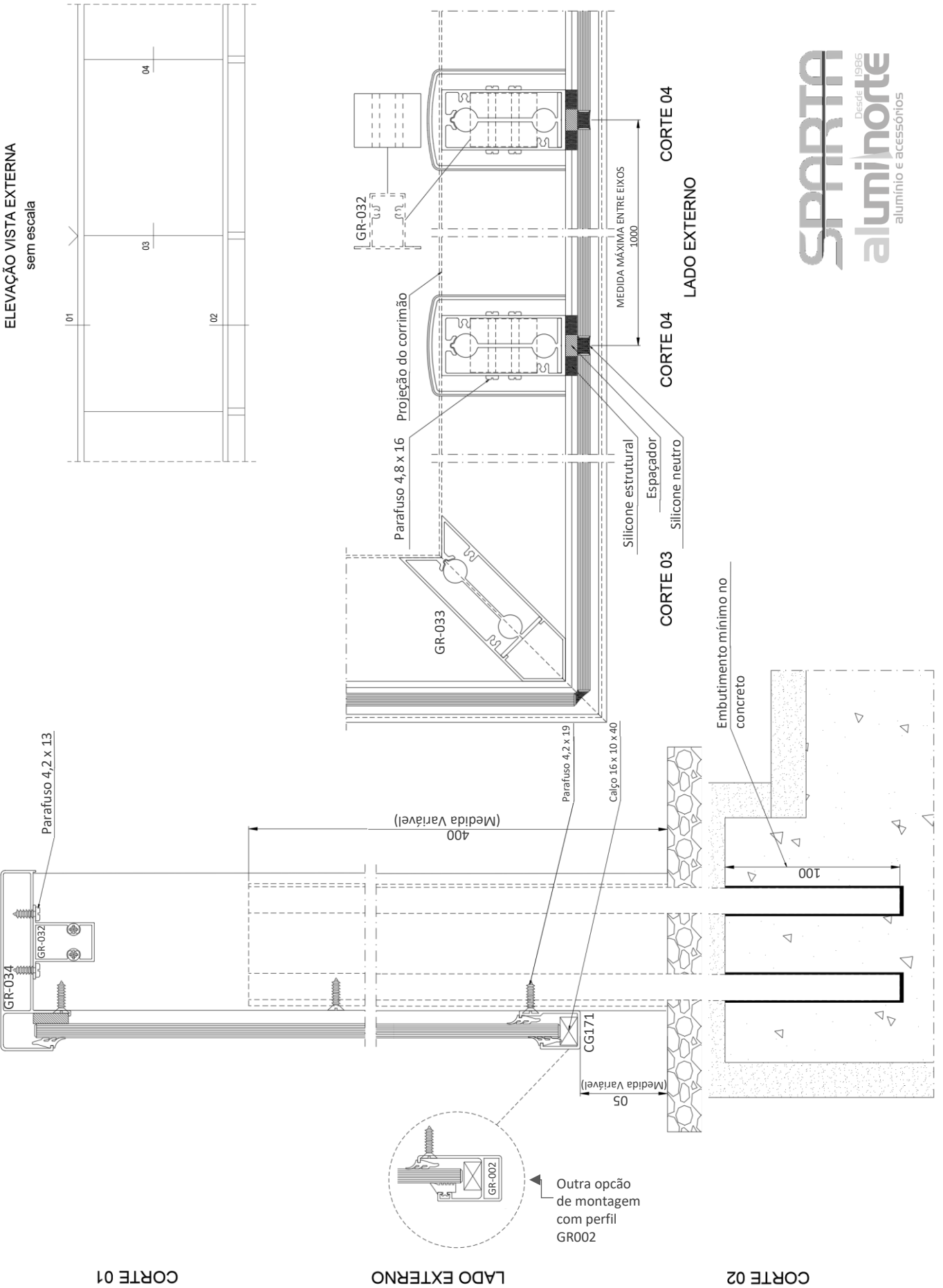

Guarda Corpo com Corrimão Reto com Barrote Vertical e Coluna de Canto com fixação direto ao chão

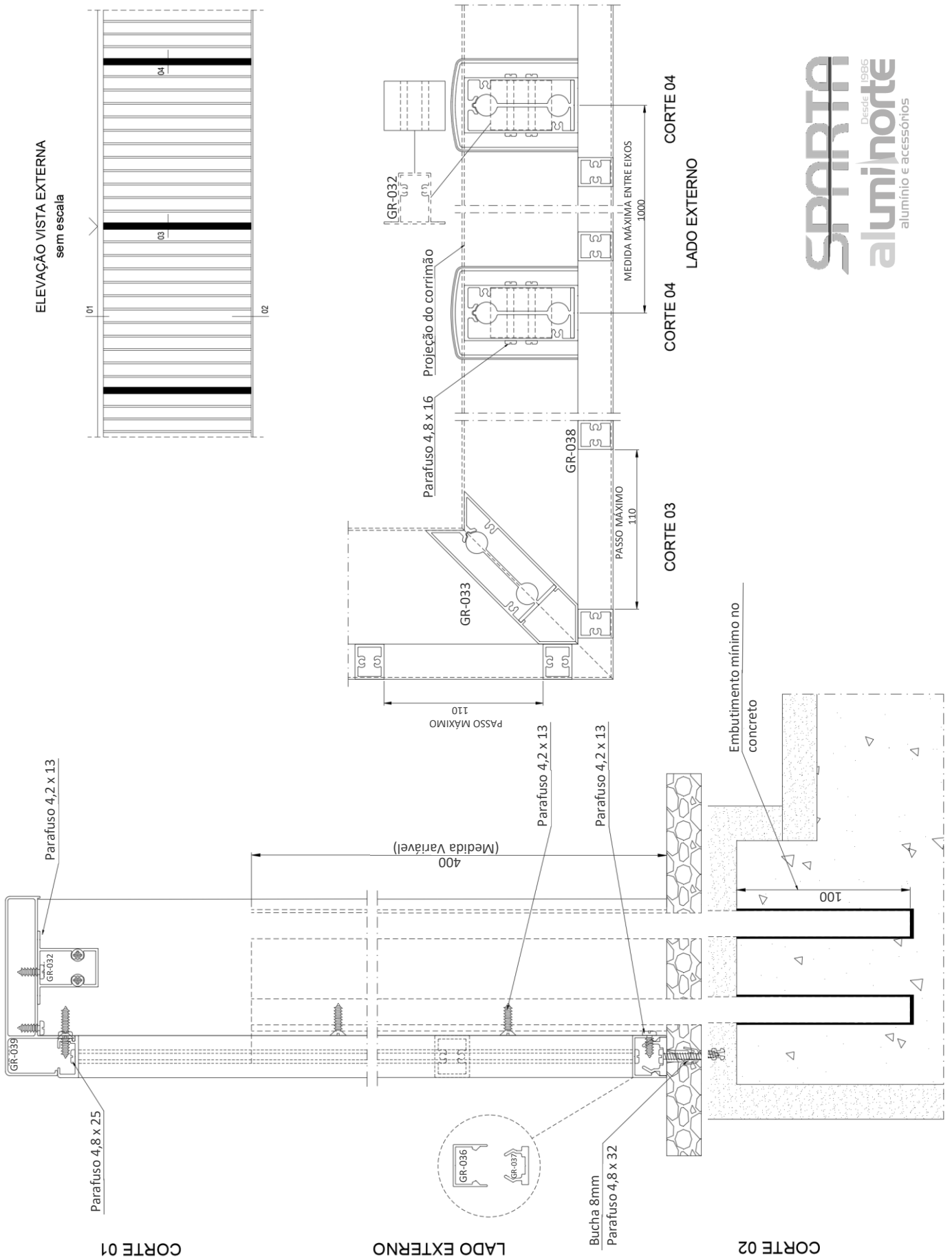

Guarda Corpo com Corrimão Reto com Barrote Vertical e Coluna de Canto com fixação no Perfil Jota

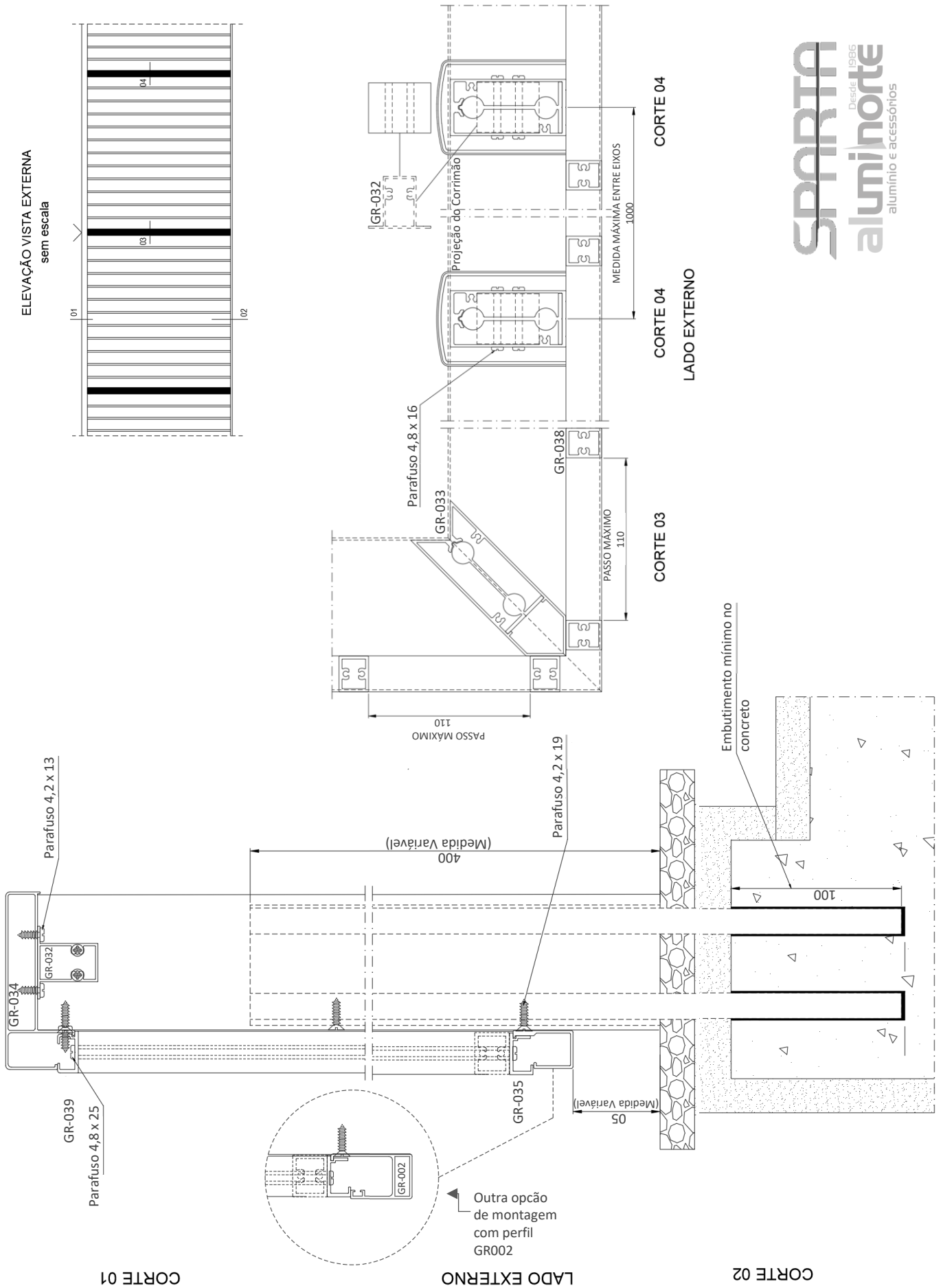

Guarda Corpo com Corrimão Curvo com Barrote Vertical e Coluna de Canto

ELEVAÇÃO VISTA EXTERNA
sem escada

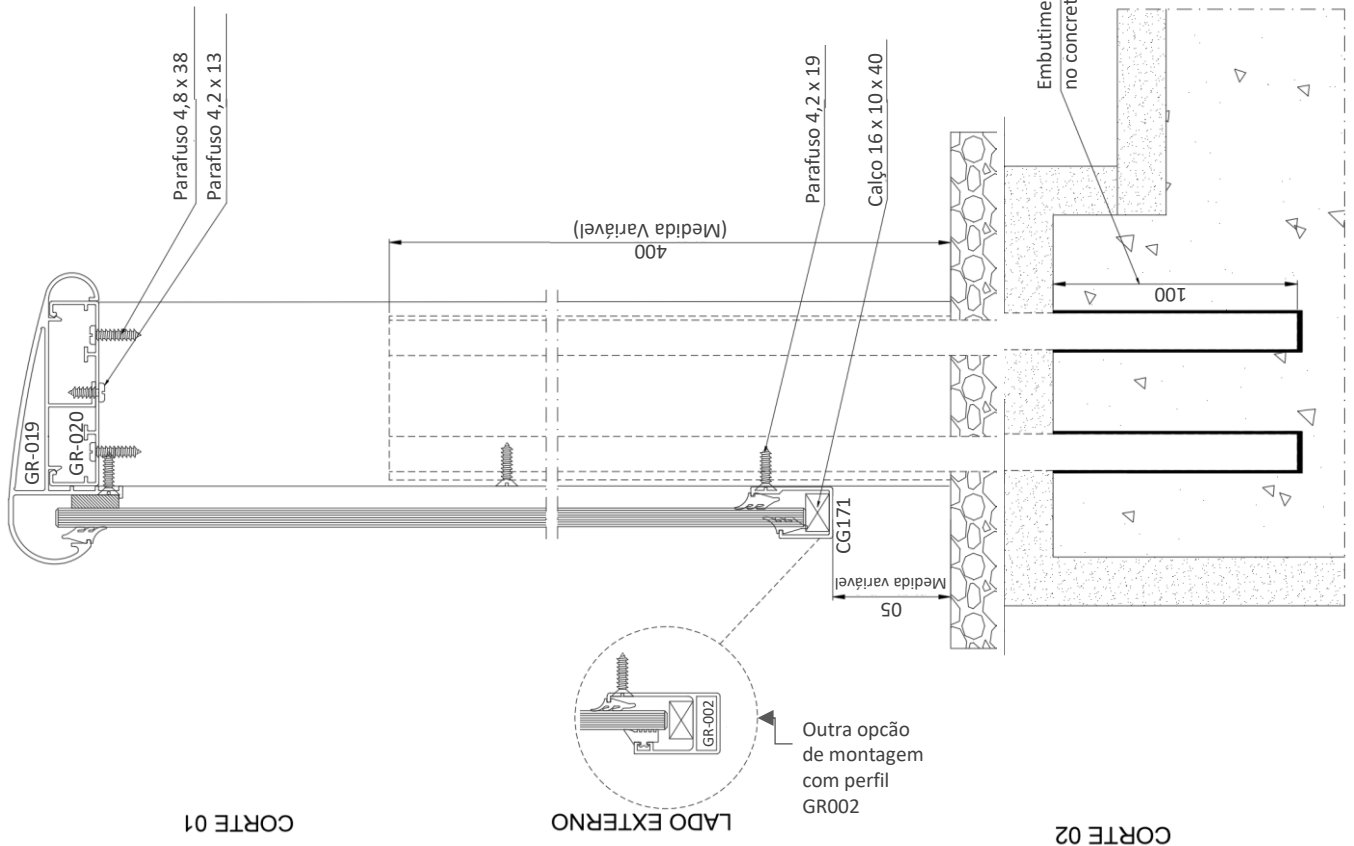
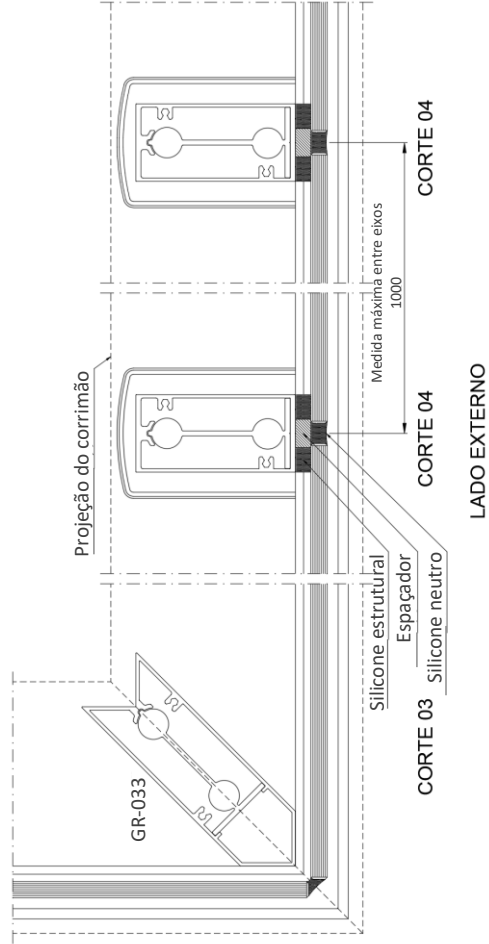
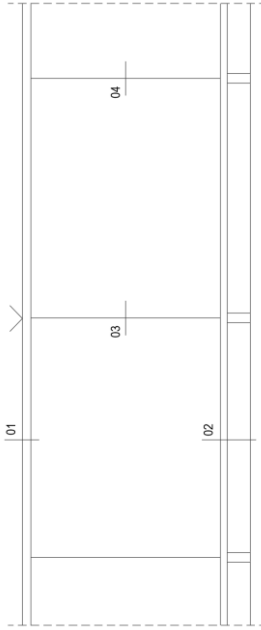

Guarda Corpo com Corrimão Curvo com Barrotes Horizontais e Coluna de Canto

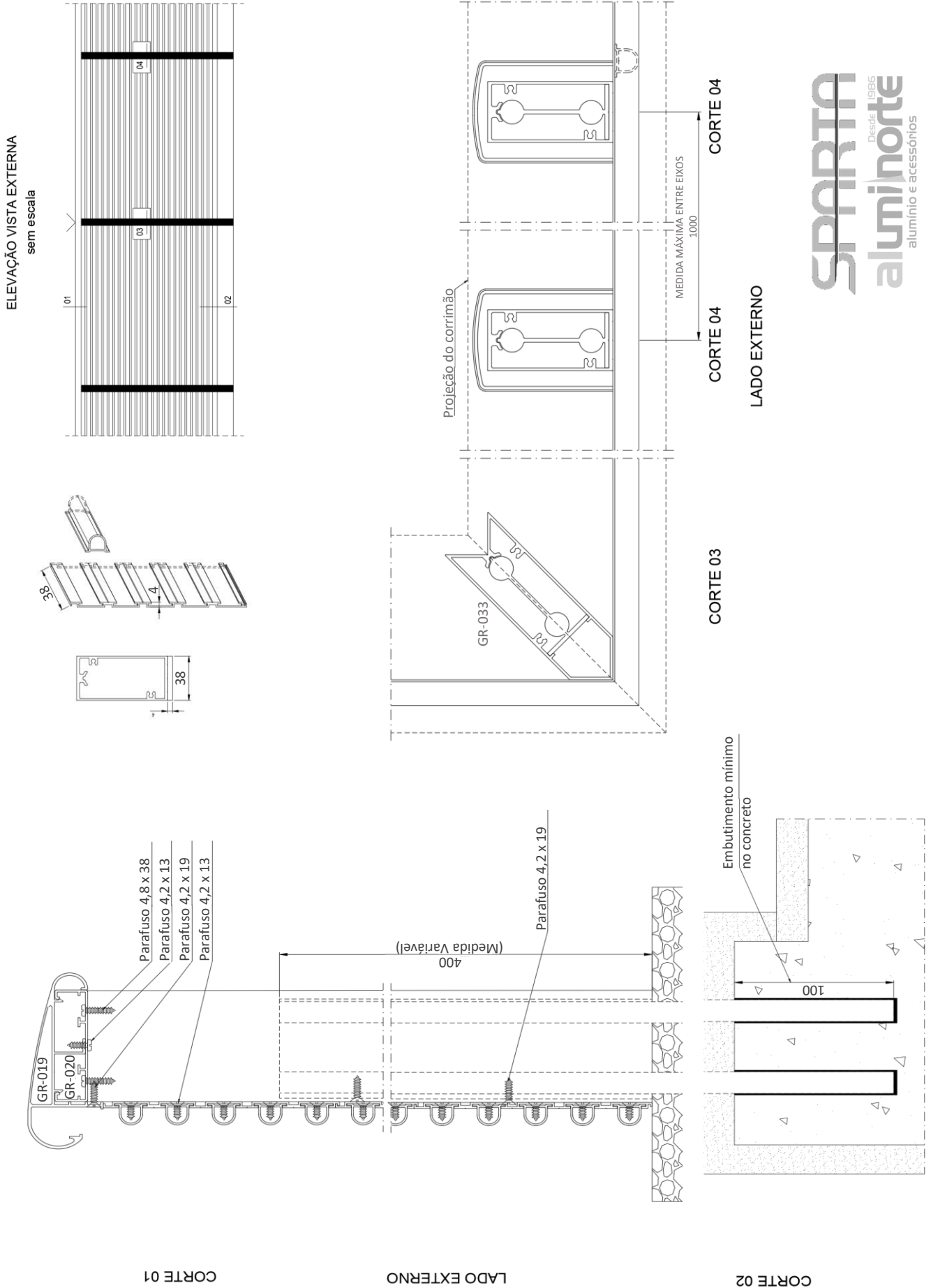

SPARTA
Desde 1986
aluminorte
alumínio e acessórios

Obrigado,

Desde 1986
aluminorte
alumínio e acessórios

Conheça os nossos
sistemas no site:

Acesse o qr code e confira!



Nos acompanhe nas
redes sociais e fique
por dentro!
@aluminorte

Ou entre em contato pelo telefone:
22814822